

## ZF 45-1

Vertical offset, direct mount marine transmission.

### Description

- Reverse reduction marine transmission with hydraulically actuated multi-disc clutches .
- Robust design with cast iron housing withstands continuous duty in workboat applications .
- Fully works tested, reliable and simple to install .
- Design, manufacture and quality control standards comply with ISO 9001 .
- Compatible with all types of engines and propulsion systems, including waterjets .

### Features

- Robust cast iron casing .
- Case hardened and precisely ground gear teeth for long life and smooth running .
- Output shaft thrust bearing designed to take maximum propeller thrust astern and ahead .
- Smooth and reliable hydraulic shifting with control lever for attachment of push-pull cable .
- Suitable for twin engine installations (same ratio and torque capacity in ahead or astern mode) .
- Replaceable oil filter cartridge .
- "SUPERSHIFT" clutch control .

### Options

- Engine-matched dual stage coupling .
- SAE 2, SAE 3, SAE 4 and B.W. adapters .
- Oil cooler complete with fittings and flexible oil hoses .
- Mounting brackets for rigid connection to foundation .
- Propeller shaft flange .
- Control cable bracket for mounting of push-pull cable to the control lever .
- Classification by all major Classification Societies on request .
- SAE «A» Power Take Off .
- Thermostatic valve for better performance of trolling valve in cold sea water .
- Trolling valve (mechanical) for slow-speed drive .
- Electric Trolling .
- Supershift (with Autotroll and Easidock) .

# ZF 45-1

## Ratings

### Pleasure Duty

	RATIOS		MAX. TORQUE		POWER/RPM		INPUT POWER CAPACITY						MAX. RPM
	'A' Pos	'B' Pos	Nm	ftlb	kW	hp	2800 rpm		3300 rpm		3800 rpm		
							kW	hp	kW	hp	kW	hp	
■	2.200	2.200	450	332	0.0471	0.0632	132	177	155	209	179	240	5500
■	2.512	2.512	450	332	0.0471	0.0632	132	177	155	209	179	240	5500
■	3.031	3.031	450	332	0.0471	0.0632	132	177	155	209	179	240	5500
■	3.741	3.741	450	332	0.0471	0.0632	132	177	155	209	179	240	5500

'A' POS = continuous running position (normally AHEAD). 'B' POS = reverse position.

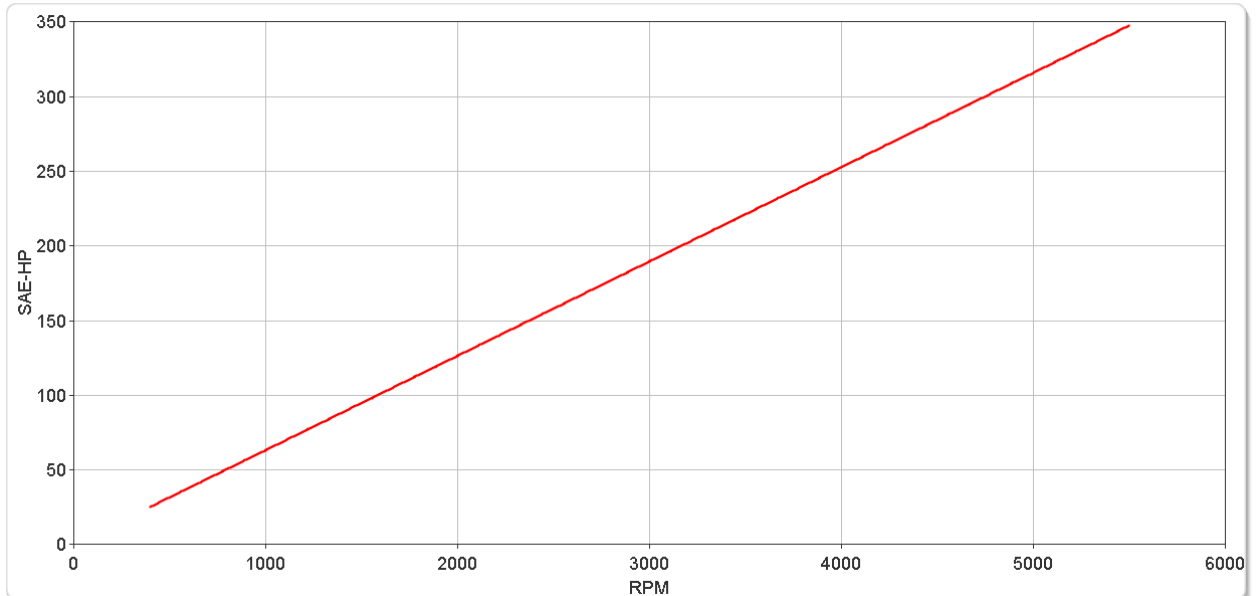
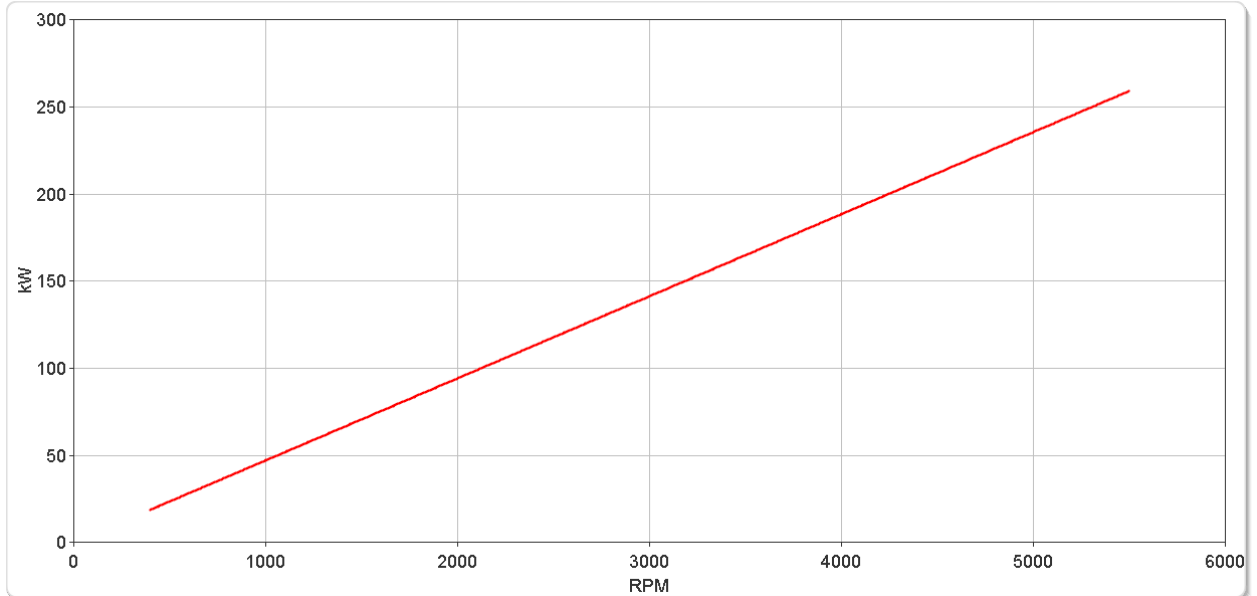

# ZF 45-1

## Ratings

### Light Duty

	RATIOS		MAX. TORQUE		POWER/RPM		INPUT POWER CAPACITY						MAX. RPM
	'A' Pos	'B' Pos	Nm	ftlb	kW	hp	2100 rpm		2500 rpm		2800 rpm		
							kW	hp	kW	hp	kW	hp	
■	2.200	2.200	435	321	0.0455	0.0611	96	128	114	153	128	171	5500
■	2.512	2.512	435	321	0.0455	0.0611	96	128	114	153	128	171	5500
■	3.031	3.031	435	321	0.0455	0.0611	96	128	114	153	128	171	5500
■	3.741	3.741	435	321	0.0455	0.0611	96	128	114	153	128	171	5500

'A' POS = continuous running position (normally AHEAD). 'B' POS = reverse position.

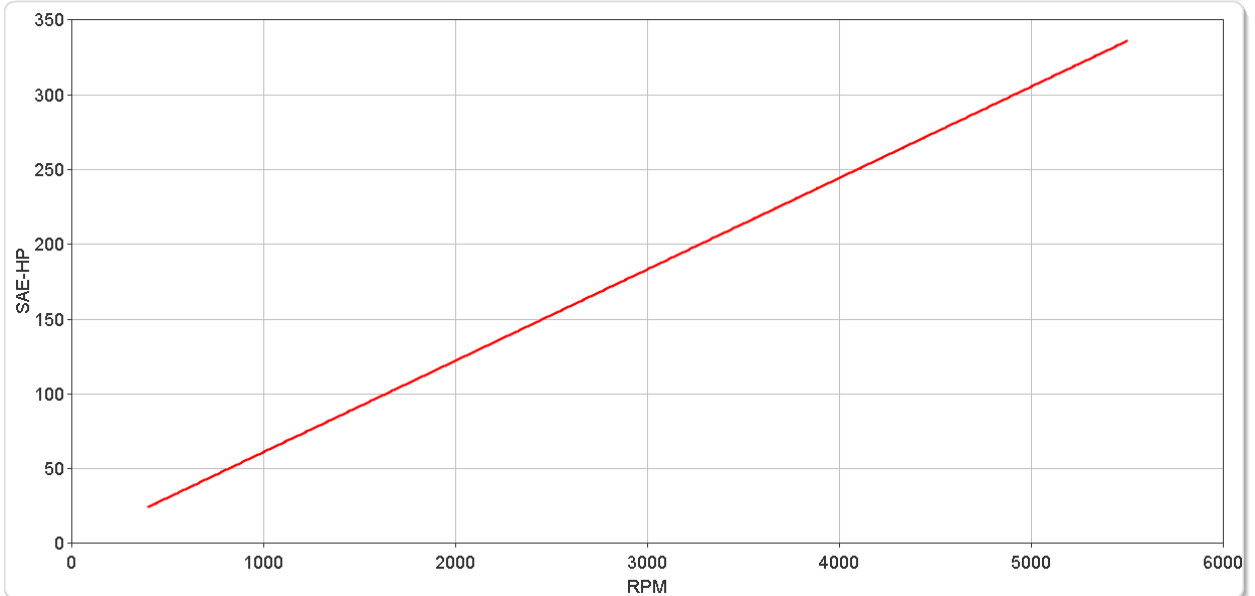
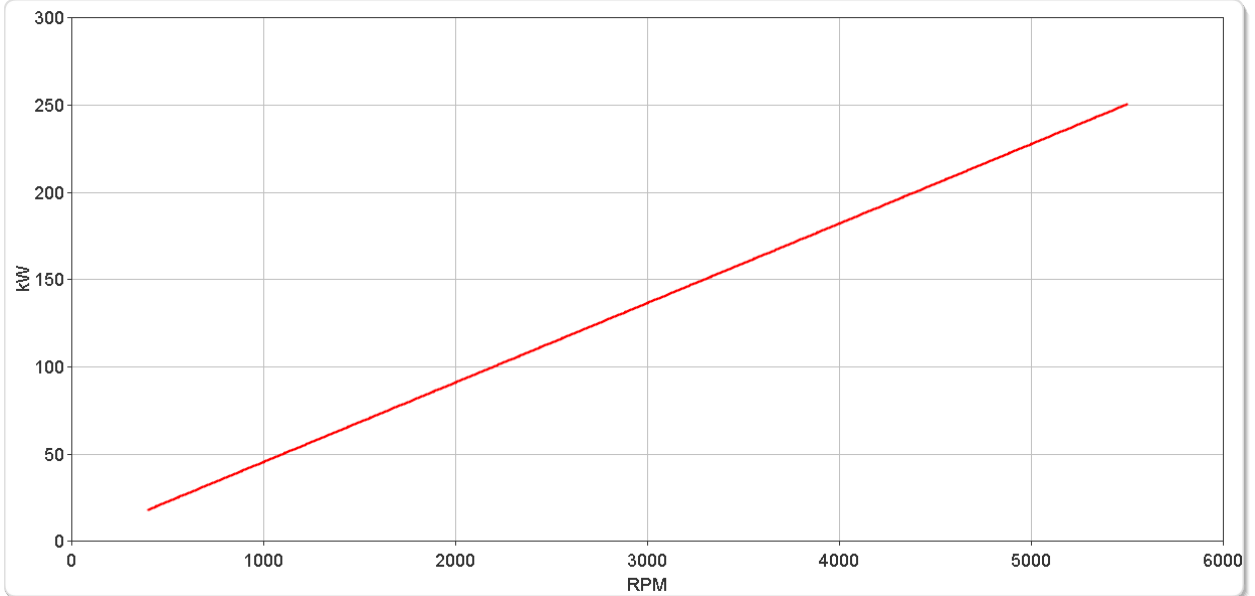

# ZF 45-1

## Ratings

### Medium Duty

	RATIOS		MAX. TORQUE		POWER/RPM		INPUT POWER CAPACITY						MAX. RPM
	'A' Pos	'B' Pos	Nm	ftlb	kW	hp	2100 rpm		2500 rpm		2800 rpm		
							kW	hp	kW	hp	kW	hp	
■	2.200	2.200	420	310	0.0440	0.0590	92	124	110	147	123	165	5500
■	2.512	2.512	420	310	0.0440	0.0590	92	124	110	147	123	165	5500
■	3.031	3.031	420	310	0.0440	0.0590	92	124	110	147	123	165	5500
■	3.741	3.741	420	310	0.0440	0.0590	92	124	110	147	123	165	5500

'A' POS = continuous running position (normally AHEAD). 'B' POS = reverse position.

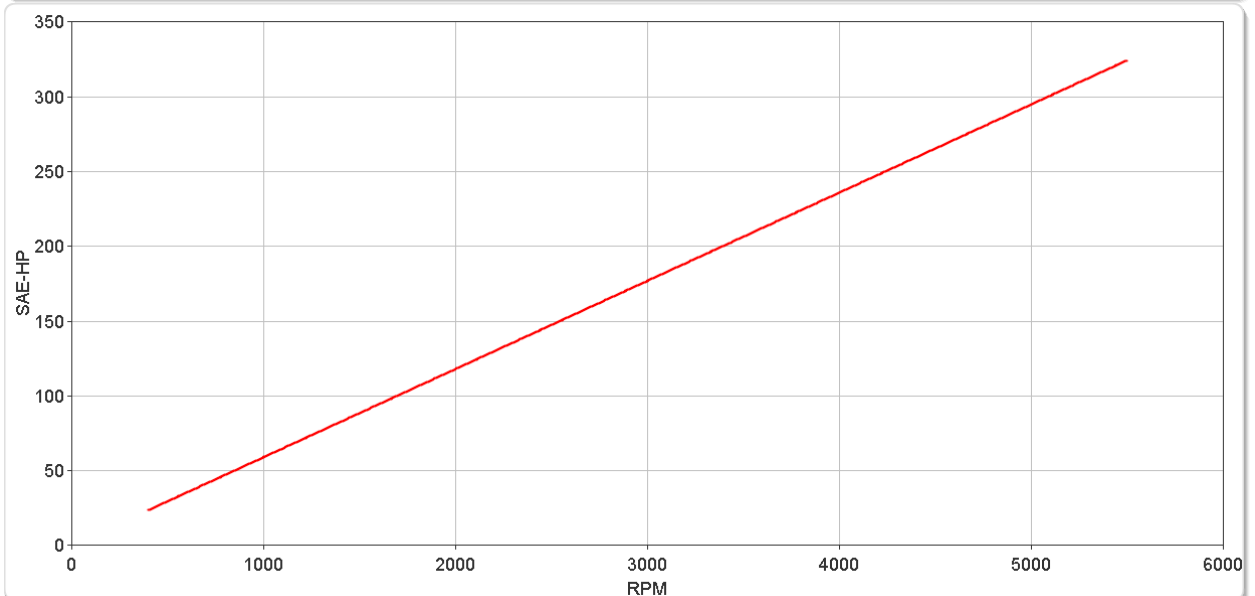
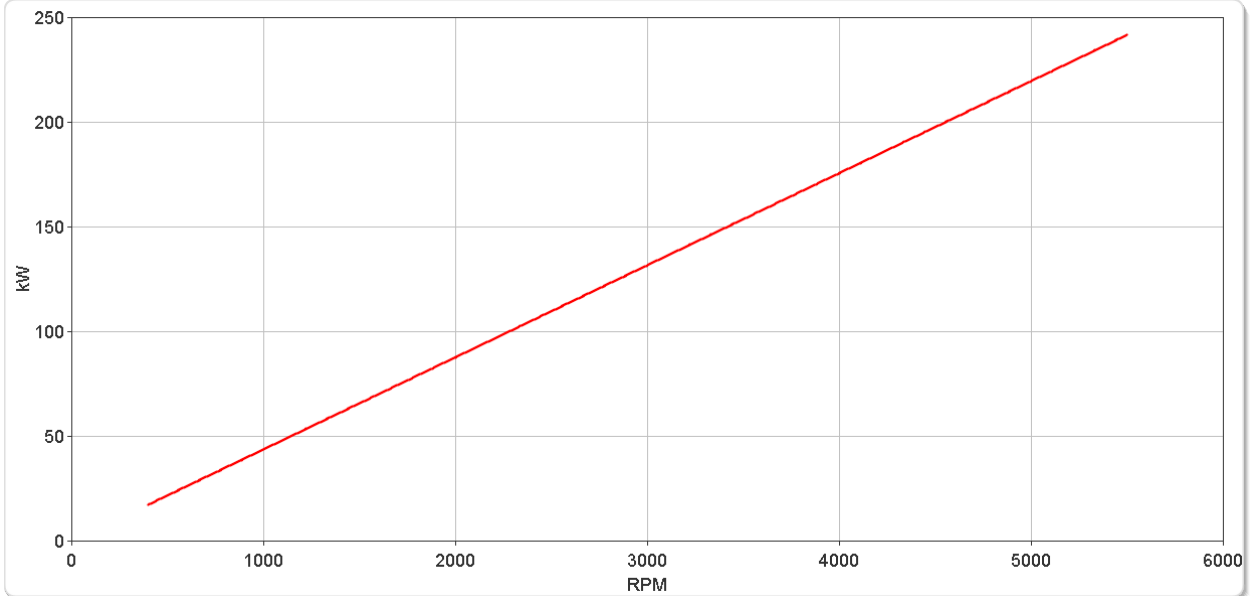

# ZF 45-1

## Ratings

### Continuous Duty

	RATIOS		MAX. TORQUE		POWER/RPM		INPUT POWER CAPACITY						MAX. RPM
	'A' Pos	'B' Pos	Nm	ftlb	kW	hp	1800 rpm		2100 rpm		2400 rpm		
							kW	hp	kW	hp	kW	hp	
■	2.200	2.200	410	302	0.0429	0.0576	77	104	90	121	103	138	3200
■	2.512	2.512	410	302	0.0429	0.0576	77	104	90	121	103	138	3200
■	3.031	3.031	410	302	0.0429	0.0576	77	104	90	121	103	138	3200
■	3.741	3.741	410	302	0.0429	0.0576	77	104	90	121	103	138	3200

'A' POS = continuous running position (normally AHEAD). 'B' POS = reverse position.

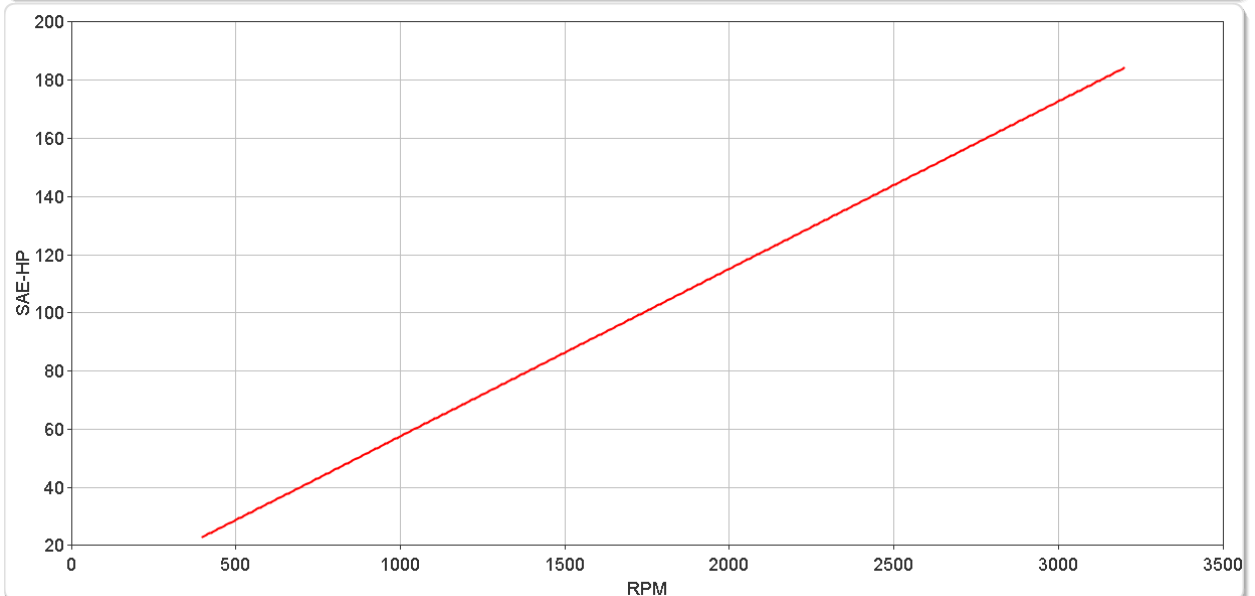
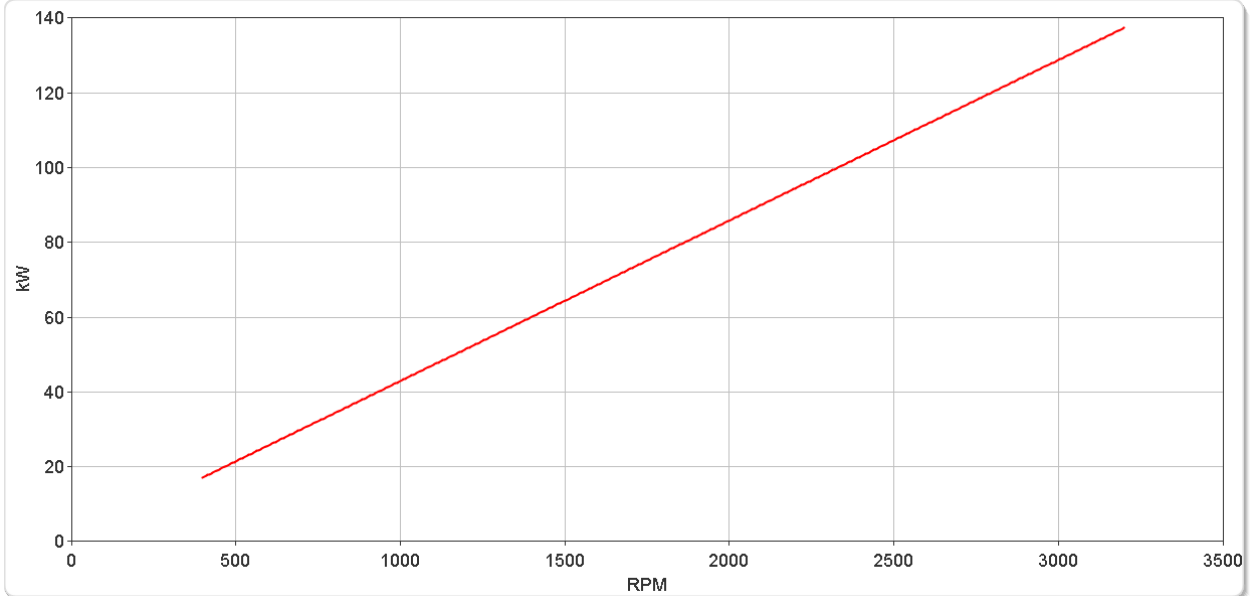

# ZF 45-1

## Dimensions

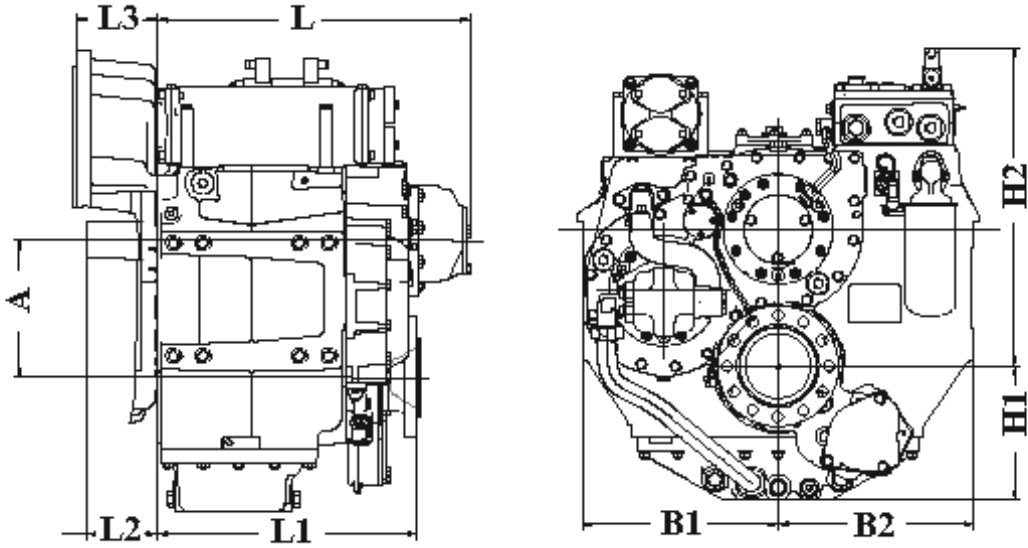

mm (inches)										Bell Hsg.
A	B <sub>1</sub>	B <sub>2</sub>	H <sub>1</sub>	H <sub>2</sub>	L	L <sub>1</sub>	L <sub>2</sub>	L <sub>3</sub>		
151 (5.94)	170 (6.69)	170 (6.69)	139 (5.47)	271 (10.7)	303 (11.9)	221 (8.70)	74.0 (2.91)	20.0 (0.79)		
Weight kg (lb)					Oil Capacity Litre (US qt)					
60.0 (132)					3.00 (3.20)					

### SAE Bell Housing Dimensions

SAE No.	A		B		C		Bolt Holes		
	mm	in	mm	in	mm	in	No.	Diameter	
2	447.68	17.625	466.73	18.375	488.95	19.25	12	10.32	13/32
3	409.58	16.125	428.63	16.875	450.85	17.75	12	10.32	13/32
4	361.95	14.25	381.0	15.0	403.23	15.875	12	10.32	13/32

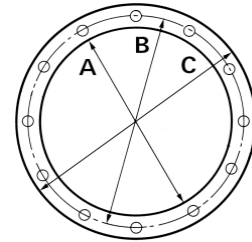

### Output Coupling Dimensions

A		B		C		D		Bolt Holes		
mm	in	mm	in	mm	in	mm	in	No.	Diameter (E)	
152	6.00	121	4.75	76.2	3.00	14.2	0.56	6	13.2	0.52

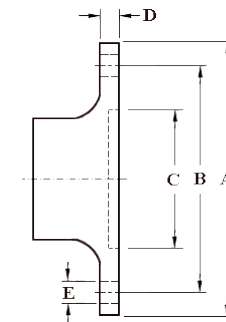

## Duty Definitions

<b>PLEASURE DUTY DEFINITION</b>	Highly intermittent operation with very large variations in engine speed and power
Average engine operating hours limit:	500 hours/year 300 hours/year for mechanical gearboxes
Typical hull forms:	Planing.
Typical applications:	Private, non-commercial, non-charter sport/leisure activities.
<b>LIGHT DUTY DEFINITION</b>	Intermittent operation with large variations in engine speed and power
Average engine operating hours limit:	2500 hours/year (for hydraulic gearboxes smaller than the ZF 650 series, 2000 hours/year).
Typical hull forms:	Planing and semi-displacement.
Typical applications:	Private and charter, sport/leisure activities, naval and police activities.
<b>MEDIUM DUTY DEFINITION</b>	Intermittent operation with some variations in engine speed and power
Average engine operating hours limit:	4000 hours/year. 3500 hours/year for gearboxes smaller than ZF 2000 series and workboat ZF W2700 series.
Typical hull forms:	Semi-displacement and displacement
Typical applications:	Charter and commercial craft (example: crew boats and fast ferries), and naval and police activities.
<b>CONTINUOUS DUTY DEFINITION</b>	Continuous operation with little or no variations in engine speed and power
Average engine operating hours limit:	Unlimited
Typical hull forms:	Displacement.
Typical applications:	Heavy duty commercial vessels, tugs, fishing boats.

## Duty Ratings

Ratings apply to marine diesel engines at the indicated speeds. At other engine speeds, the respective power capacity (kW) of the transmission can be obtained by multiplying the Power/Speed ratio by the speed.

Approximate conversion factors:

1 kW = 1.36 metric hp

1 kW = 1.34 U.S. hp (SAE)

1 U.S. hp = 1.014 metric hp

1 Nm = 0.74 lb.ft.

Ratings apply to right hand turning engines, i.e. engines having counterclockwise rotating flywheels when viewing the flywheel end of the engine.

These ratings allow full power through forward and reverse gear trains, unless otherwise stated.

Contact your nearest ZF Sales and Service office for ratings applicable to gas turbines, gasoline (petrol) engines, as well as left hand turning engines, and marine transmissions for large horsepower capacity engines.

Ratings apply to marine transmissions currently in production or in development and are subject to change without prior notice.

**NOTE:** THE MAXIMUM RATED INPUT POWER MUST NOT BE EXCEEDED (SEE RESPECTIVE RATINGS IN THE TECHNICAL DATA SHEETS)

## Safe Operating Notice

The safe operation of ZF products depends upon adherence to technical data presented in our brochures. Safe operation also depends upon proper installation, operation and routine maintenance and inspection under prevailing conditions and recommendations set forth by ZF. Damage to transmission caused by repeated or continuous emergency manoeuvres or abnormal operation is not covered under warranty. It is the responsibility of users and not ZF to provide and install guards and safety devices, which may be required by recognized safety standards of the respective country (e.g. for U.S.A. the Occupational Safety Act of 1970 and its subsequent provisions).

## Monitoring Notice

The safe operation of ZF products depends upon adherence to ZF monitoring recommendations presented in our operating manuals, etc. It is the responsibility of users and not ZF to provide and install monitoring devices and safety interlock systems as may be deemed prudent by ZF. Consult ZF for details and recommendations.

## Torsional Responsibility and Torsional Couplings

The responsibility for ensuring torsional compatibility rests with the assembler of the drive and driven equipment. ZF can accept no liability for gearbox noise caused by vibrations or for damage to the gearbox, the flexible coupling or to other parts of the drive unit caused by this kind of vibration. Contact ZF for further information and assistance. ZF recommends the use of a torsional limit stop for single engine powered boats, wherein loss of propulsion power can result in loss of control. It is the buyer's responsibility to specify this option, which can result in additional cost and a possible increase in installation length.

ZF can accept no liability for personal injury, loss of life, or damage or loss of property due to the failure of the buyer to specify a torsional limit stop. ZF selects torsional couplings on the basis of nominal input torque ratings and commonly accepted rated engine governed speeds. Consult ZF for details concerning speed limits of standard offering torsional couplings, which can be less than the transmission limit. Special torsional couplings may be required for Survey Society Ice Classification requirements.

